

Control Valves

Series 3000

Low Flow Valves

BUROCCO

INDUSTRIAL VALVES srl

Technical data

Size (DN)	DN 10—50 (1/4" - 2")
Pressure rating	UNI/DIN PN16-100, ANSI 150-600
Connections	Flanges UNI PN16-100 Flanges ANSI 150-600; Threaded G NPT; Welded BW, SW; Clamp
Type sealing	Soft (Class VI) Metallic (Class IV - V - VI)
Characteristic Action	Equalpercentage (eqp%) Pneumatic with diaphragm (supply max 3 bar)
Temperature	from -196 to +350 °C

Description

The valves 2-ways 3000 series are designed also for the control of small flow "microflow" in pilot and experimental plants. The body is constructed from stainless steel bars or special alloys and is therefore completely configurable according to the type of application. The valves offer superior performance in almost all applications with a wide temperature range. All Burocco valves are delivered after testing and calibration and ready for a long utilize, without maintenance.

Options

- ⇒ Characteristic linear
- ⇒ High temperature extension (finned bonnet)
- ⇒ Extension (- 100°C)
- ⇒ Cryogenic extension (- 196 °C)
- ⇒ Bellows seal (double wall PN16, triple wall PN40)
- ⇒ Full stainless steel actuator for corrosive environment
- ⇒ 3-way (mixing or diverting) valves (see brochure 3003)
- ⇒ Special alloys for body: Hastelloy, Duplex, Monel
- ⇒ Special rating PN160/250
- ⇒ Stroke limiter
- ⇒ Handwheel for emergency operation
- ⇒ Valve positioners
- ⇒ Limit switches
- ⇒ Position feedback
- ⇒ Airset
- ⇒ Electric linear actuators
(230 V AC, 110/115 V AC, 24 VAC/DC)
- ⇒ Hand operating (manual)
- ⇒ Pneumatic with piston actuator (service ON/OFF)

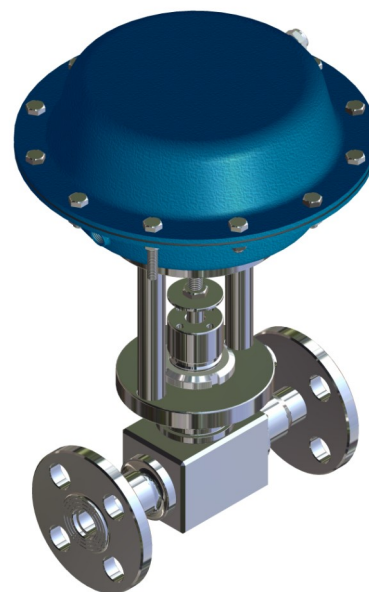

Flow rate coefficient (CV)

DN	¼" (10)	½" (15)	¾" (20)	1" (25)	1¼" (32)	1½" (40)	2" (50)
CV	-	-	-	-	-	-	48
	-	-	-	-	-	28	28
	-	-	-	-	18	18	18
	-	-	-	12	12	12	12
	-	-	7	7	7	7	7
	-	4	4	4	4	4	4
	2,5	2,5	2,5	2,5	2,5	2,5	2,5
	2	2	2	2	2	2	2
	1,5	1,5	1,5	1,5	1,5	1,5	1,5
	1	1	1	1	-	-	-
	0,8	0,8	0,8	0,8	-	-	-
	0,5	0,5	0,5	0,5	-	-	-
	0,3	0,3	0,3	0,3	-	-	-
	0,2	0,2	0,2	0,2	-	-	-
	0,1	0,1	0,1	0,1	-	-	-
	0,08	0,08	0,08	0,08	-	-	-
	0,06	0,06	0,06	0,06	-	-	-
	0,05	0,05	0,05	0,05	-	-	-
	0,03	0,03	0,03	0,03	-	-	-
	0,02	0,02	0,02	0,02	-	-	-
0,01	0,01	0,01	0,01	-	-	-	

Burocco reserves the right to make improvements without prior notice 04/14

Control Valves
Series 3000
 Low Flow Valves

BUROCCO
 INDUSTRIAL VALVES srl

BUROCCO INDUSTRIAL VALVES srl VIA NOVEIS, 33 - 13867 PRAY (BI) - ITALY

burocco@burocco.it — www.burocco.it

Tel.: +39 015 76.72.78 — Fax: +39 015 76.71.36

Materials	
Valve body	S.S.316L
Trim (plug - seat)	S.S.316L / 17-4PH / S.S.316L+Stellite /
Steam	316L / Hastelloy / Duplex / Monel
Packing	PTFE, PTFE+'OR' FPM, special
Body gasket	PTFE, SIL C4500, special
Acuator	FE (epoxy varnish) Stainless steel
Yoke	Stainless steel

Control characteristic

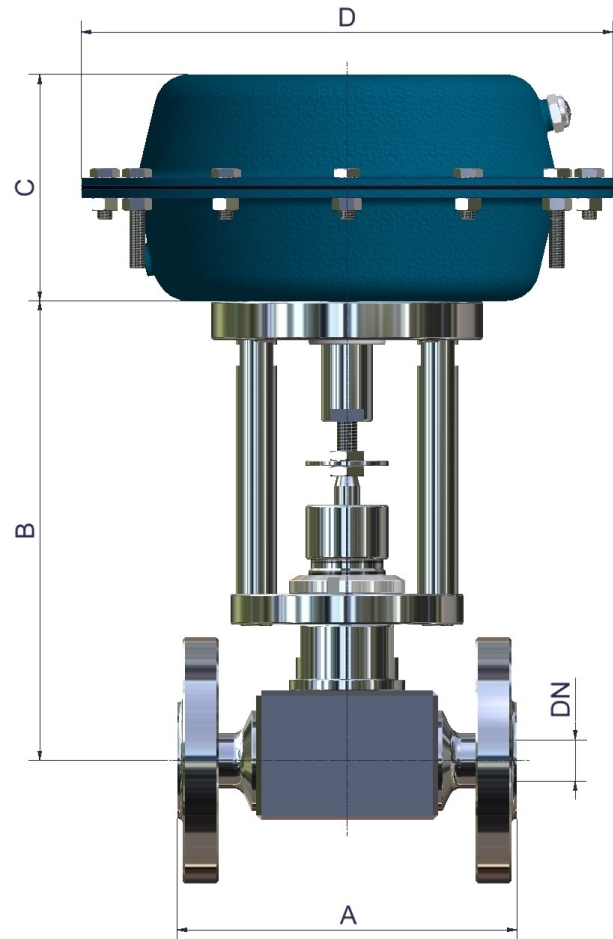
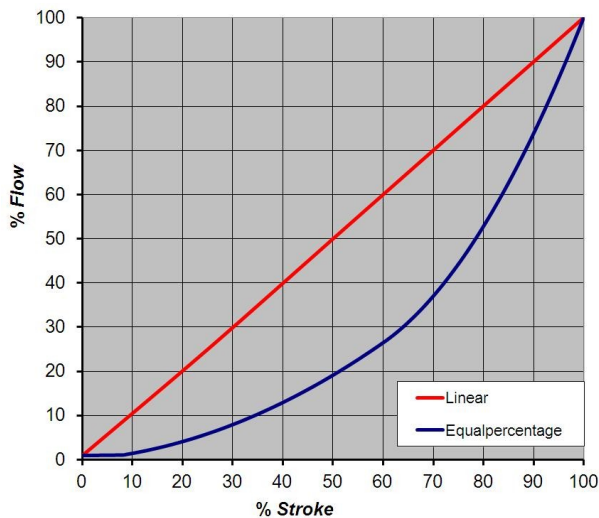

Dimensions Series 3000 face-to-face (mm)

A Flanged valves						A Threaded / welding valves			
DN	DIN PN		ANSI CLASS			DN	G / NPT Female	BW	SW
	16-40	63-100	150	300	600				
15	130	210	178	190	203	1/4" - 1/2"	112	124	124
20	150	230	181	194	206	3/4"	142	145	142
25	160	230	184	197	210	1"	142	155	142
32	**	260	-	-	-	1 1/4"	190	**	190
40	200	260	222	235	251	1 1/2"	190	194	190
50	230	300	254	267	286	2"	190	224	190

** on request

End connections



Flanges UNI/DIN - ANSI

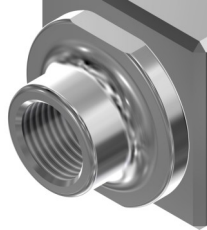

Threaded GAS - NPT



Welded BW

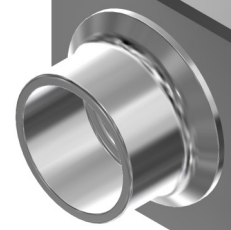

Welded SW

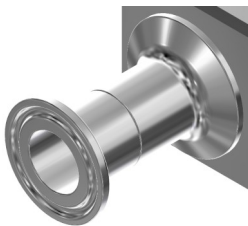

Clamp ISO

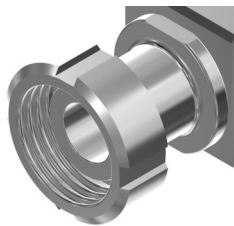

DIN 11851 (male)

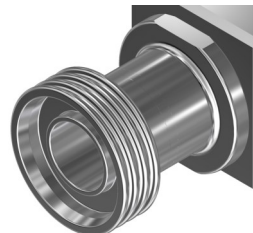

DIN 11851 (female)

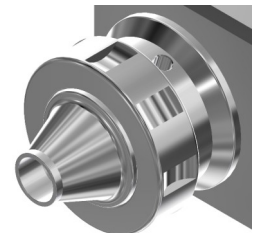

Special (on request)

Bonnet specifications (temperatures limit employment)

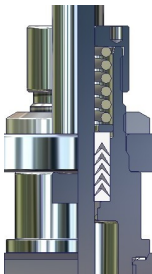

Standard (-30°C / +250 °C)

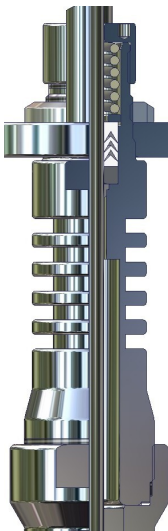

Finned (-30°C / +350 °C)



Bellows (-100°C / +250 °C)

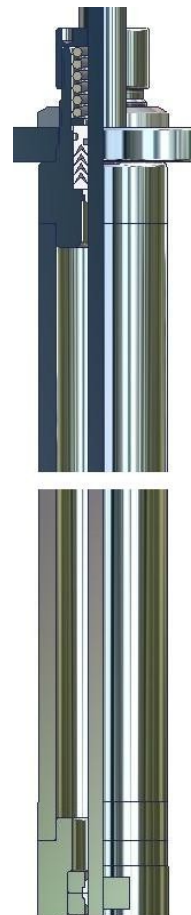

Cryogenic (-196°C / +180 °C)

Control Valves

Series 3000

Low Flow Valves

Dimensions Series 3000 (mm)						
B at different bonnet designs						
DN		Standard	-100 °C (extension)	-200 °C (cryogenic)	High Temp. (finned)	Bellows
15	¼" - ½"	180	305	660	305	300
20	¾"	190	310	665	310	305
25	1"	190	310	665	310	305
32	1 ¼"	220	On request	On request	On request	405
40	1 ½"	220	On request	On request	On request	405
50	2"	220	On request	On request	On request	405

Weight Series 3000 (kg) flanged valves (without actuator)									
DN	Weight with standard bonnet					Extra weight with bonnet extension			
	PN16-40	PN63-100	ANSI 150	ANSI 300	ANSI 600	-100 °C	-200 °C	High Temp.	Bellows
15	5	6,5	5	5,5	6	+ 1	+ 3	+ 1	+ 1,5
20	7,5	8,5	7,5	7,5	8,5	+ 1	+ 3	+ 1	+ 1,5
25	8,5	9,5	8	8,5	9,5	+ 1	+ 3	+ 1	+ 1,5
32	15,5	On request	On request	On request	On request	On request	On request	On request	+ 3
40	15,5	On request	On request	On request	On request	On request	On request	On request	+ 3
50	18	On request	On request	On request	On request	On request	On request	On request	+ 3

Weight Series 3000 (kg) threaded, welded valves					
DN	Weight with standard bonnet (without actuator)	Extra weight with bonnet extension			
		-100 °C	-200 °C	High Temp.	Bellows
¼" - ½"	3,5	+ 1	+ 3	+ 1	+ 1,5
¾"	5,5	+ 1	+ 3	+ 1	+ 1,5
1"	6	+ 1	+ 3	+ 1	+ 1,5
1 ¼"	12	On request	On request	On request	+ 3
1 ½"	12	On request	On request	On request	+ 3
2"	13,5	On request	On request	On request	+ 3

Dimensions (mm) and weight (kg) Actuators				
Actuator	C	D	Air connection	Weight
S-200	90	205	1/8" GAS FF	2,5
S-275	100	275	1/4" GAS FF	6
S-340	135	340	1/4" GAS FF	13
S-430	140	430	1/4" GAS FF	17